

《参考：各空室のレイアウト》

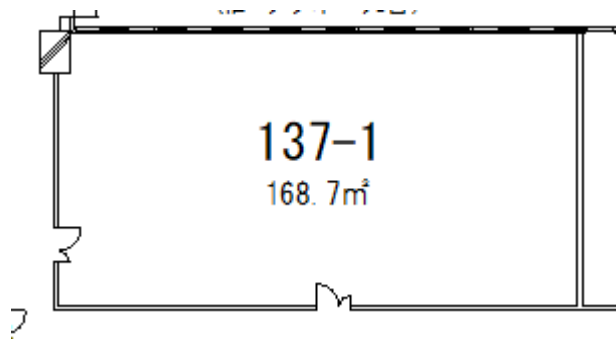

(水産棟 3階 No.137-1)

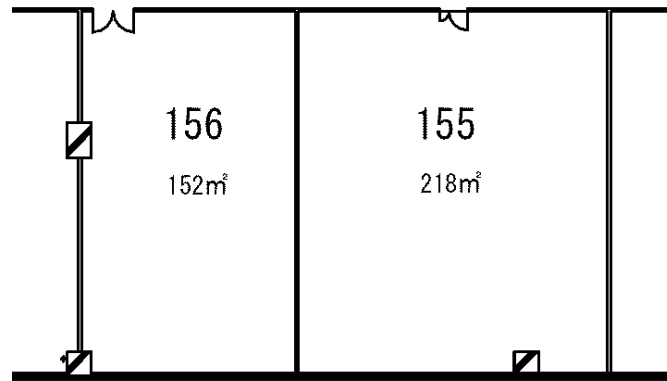

(水産棟 3階 No.155,156)

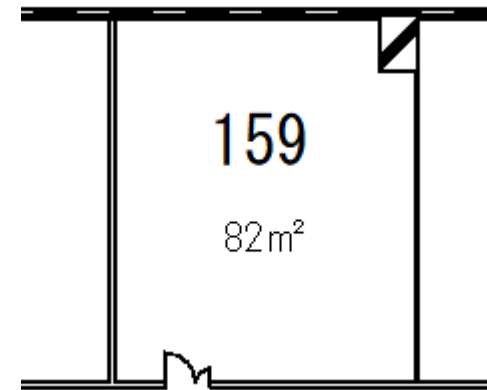

(水産棟 4階 No.159)

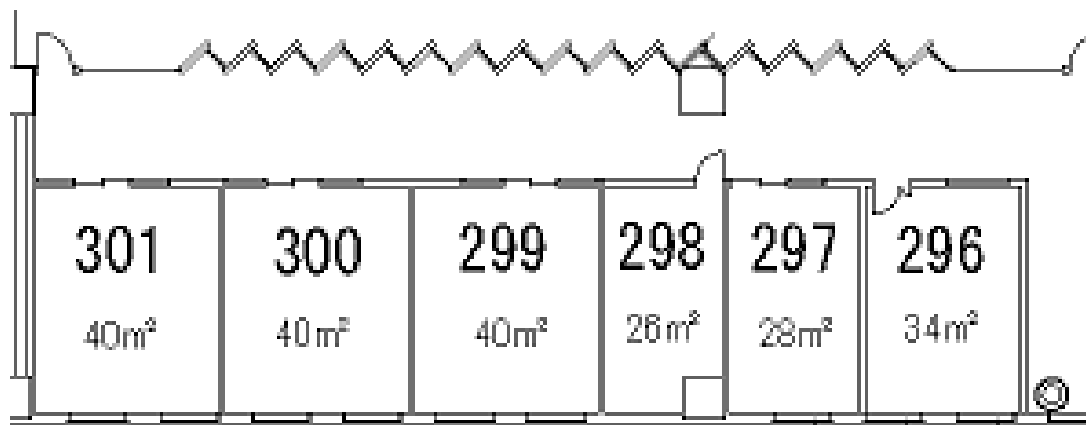

(青果棟 3階 No.297,298,299,300,301)

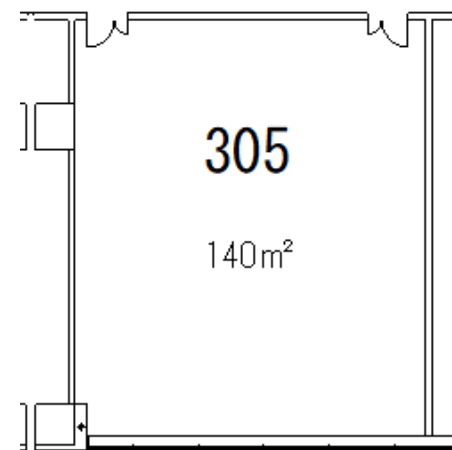

(青果棟 3階 No.305)

※いずれも現況優先

《参考：各空室のレイアウト》



(青果棟 3階 No.306)

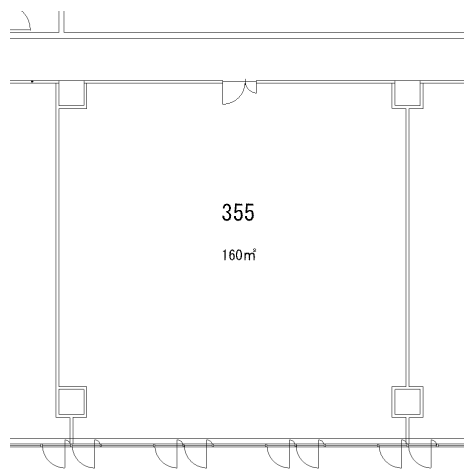

(保冷配送センター 3階 No.355)

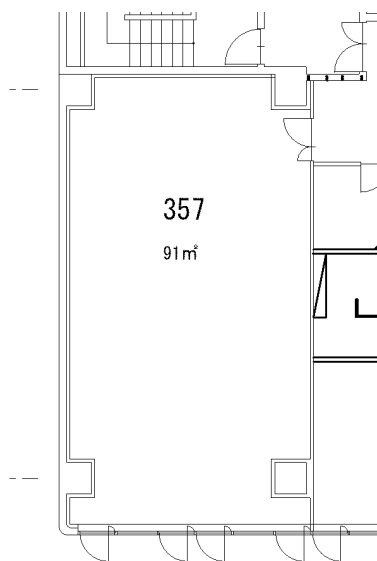

(保冷配送センター 3階 No.357)

※いずれも現況優先